

---

**VOLTAGE DETECTOR**  
**R×5VL SERIES**

**APPLICATION MANUAL**

**RICOH**

**ELECTRONIC DEVICES DIVISION**

## NOTICE

---

1. The products and the product specifications described in this application manual are subject to change or discontinuation of production without notice for reasons such as improvement. Therefore, before deciding to use the products, please refer to Ricoh sales representatives for the latest information thereon.
2. This application manual may not be copied or otherwise reproduced in whole or in part without prior written consent of Ricoh.
3. Please be sure to take any necessary formalities under relevant laws or regulations before exporting or otherwise taking out of your country the products or the technical information described herein.
4. The technical information described in this application manual shows typical characteristics of and example application circuits for the products. The release of such information is not to be construed as a warranty of or a grant of license under Ricoh's or any third party's intellectual property rights or any other rights.
5. The products listed in this document are intended and designed for use as general electronic components in standard applications (office equipment, computer equipment, measuring instruments, consumer electronic products, amusement equipment etc.). Those customers intending to use a product in an application requiring extreme quality and reliability, for example, in a highly specific application where the failure or misoperation of the product could result in human injury or death (aircraft, spacevehicle, nuclear reactor control system, traffic control system, automotive and transportation equipment, combustion equipment, safety devices, life support system etc.) should first contact us.
6. We are making our continuous effort to improve the quality and reliability of our products, but semiconductor products are likely to fail with certain probability. In order prevent any injury to persons or damages to property resulting from such failure, customers should be careful enough to incorporate safety measures in their design, such as redundancy feature, fire-containment feature and fail-safe feature. We do not assume any liability or responsibility for any loss or damage arising from misuse or inappropriate use of the products.
7. Anti-radiation design is not implemented in the products described in this application manual.
8. Please contact Ricoh sales representatives should you have any questions or comments concerning the products or the technical information.

June 1995

# R5VL SERIES

## APPLICATION MANUAL

### CONTENTS

---

<b>OUTLINE</b> .....	1
<b>FEATURES</b> .....	1
<b>APPLICATIONS</b> .....	1
<b>BLOCK DIAGRAMS</b> .....	2
<b>TIME CHART</b> .....	2
<b>DEFINITION OF OUTPUT DELAY TIME <math>t_{plh}</math></b> .....	2
<b>SELECTION GUIDE</b> .....	4
<b>PIN CONFIGURATION</b> .....	5
<b>PIN DESCRIPTION</b> .....	5
<b>ABSOLUTE MAXIMUM RATINGS</b> .....	6
<b>ELECTRICAL CHARACTERISTICS</b> .....	7
<b>ELECTRICAL CHARACTERISTICS BY DETECTOR THRESHOLD</b> .....	10
<b>OPERATION</b> .....	14
<b>TEST CIRCUITS</b> .....	15
<b>TYPICAL CHARACTERISTICS</b> .....	16
1) Supply Current vs. Input Voltage .....	16
2) Detector Threshold vs. Temperature .....	16
3) Output Voltage vs. Input Voltage .....	17
4) Nch Driver Output Current vs. $V_{DS}$ .....	18
5) Nch Driver Output Current vs. Input Voltage .....	18
6) Pch Driver Output Current vs. Input Voltage .....	19
7) Output Delay Time vs. Load Capacitance .....	20
<b>TYPICAL APPLICATIONS</b> .....	21
• R5VLxA CPU Reset Circuit(Nch Open Drain Output) .....	21
• R5VLxC CPU Reset Circuit (CMOS Output) .....	21
• R5VLxA Output delay Time Circuit .....	21
• Memory Back-up Circuit .....	21
• Voltage Level Indicator Circuit (lighted when the power runs out) .....	22
• Detector Threshold Changing Circuit .....	22
• Window Comparator Circuit .....	22
• Excessive Charge Preventing Circuit .....	22
<b>PACKAGE DIMENSIONS</b> .....	24
<b>TAPING SPECIFICATIONS</b> .....	25

### R $\times$ 5VL SERIES

#### OUTLINE

The R $\times$ 5VL Series are voltage detector ICs with high detector threshold accuracy and ultra-low supply current by CMOS process. Each of these ICs consists of a voltage reference unit, a comparator, resistors for voltage detection, an output driver and a hysteresis circuit.

The detector threshold is fixed with high accuracy.

Two output Types, Nch open drain type and CMOS type, are available.

Three types of packages, TO-92, SOT-89 (Mini-power Mold), SOT-23-5 (Mini-mold), are available.

#### FEATURES

- Ultra-low Supply Current.....TYP. 1.0 $\mu$ A (V<sub>DD</sub>=3.0V)
- Broad Operating Voltage Range.....1.5V to 10.0V
- Detector Threshold.....Stepwise setting with a step of 0.1V in the range of 2.0V to 6.0V is possible (refer to Selection Guide).
- High Accuracy Detector Threshold ..... $\pm$ 2.5%
- Low Temperature-Drift Coefficient of Detector Threshold .....TYP.  $\pm$ 100ppm/ $^{\circ}$ C
- Two Output Types.....Nch Open Drain and CMOS
- Three Types of Packages.....TO-92, SOT-89 (Mini-power Mold), SOT-23-5 (Mini-mold)

#### APPLICATIONS

- CPU & Logic Circuit Reset
- Battery Checker
- Window Comparator
- Wave Shaping Circuit
- Battery Back-Up Circuit
- Power Failure Detector

## BLOCK DIAGRAMS

### • Nch Open Drain Output (R×5VL×A)

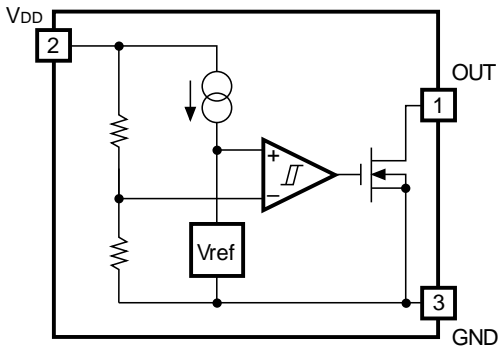

### • CMOS Output (R×5VL×C)

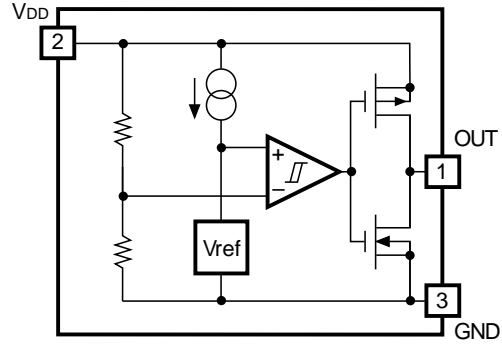

## TIME CHART

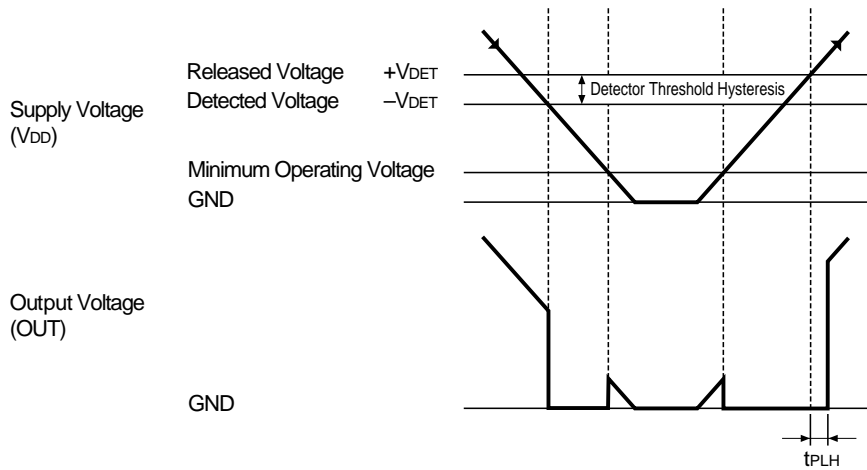

## DEFINITION OF OUTPUT DELAY TIME tPLH

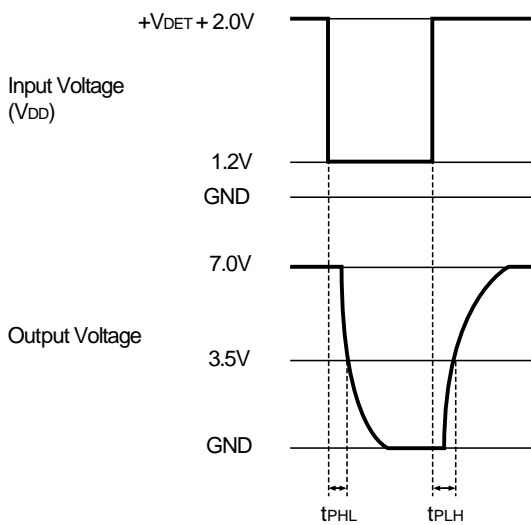

Nch Open Drain Output

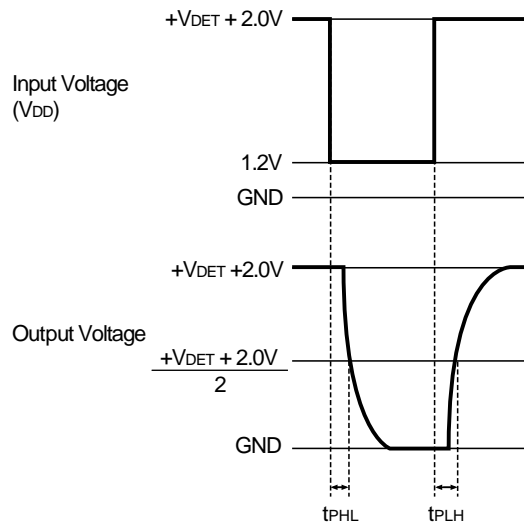

CMOS Output

Output Delay Time  $t_{PLH}$  is defined as follows:

1. In the case of Nch Open Drain Output:

When the time at which a pulse voltage which increases from 1.2V to  $+V_{DET}+2.0V$  is applied to VDD is Time A, and the time at which the output reaches 3.5V under the conditions that the output pin (OUT) is pulled up to 7V by a resistor of 100k $\Omega$  is Time B, the time period from Time A through Time B.

2. In the case of CMOS Output:

When the time at which a pulse voltage which increases from 1.2V to  $+V_{DET} +2.0V$  is applied to VDD is Time A, and the time at which the output voltage reaches the voltage of  $(+V_{DET}+2.0V)/2$  is Time B, the time period from Time A through Time B.

## SELECTION GUIDE

The package type, the detector threshold, the output type, the packing type, and the taping type of R5VL series can be designated at the user's request by specifying the part number as follows:

R5VLxxx-xx ← Part Number  
 ↑     ↑ ↑↑     ↑  
 a     b cd     e

Code	Contents
a	Designation of Package Type: E: TO-92 H: SOT-89 (Mini-power Mold) N: SOT-23-5 (Mini-mold)
b	Setting Detector Threshold (-VDET): Stepwise setting with a step of 0.1V in the range of 2.0V to 6.0V is possible.
c	Designation of Output Type: A: Nch Open Drain C: CMOS
d	Designation of Packing Type: A: Taping C: Antistatic bag for TO-92 and samples
e	Designation of Taping Type: Ex. TO-92: RF, RR, TZ SOT-89: T1, T2 SOT-23-5: TR, TL (refer to Taping Specifications) "TZ", "T1" and "TR" are prescribed as a standard.

For example, the product with Package Type SOT-89, Detector Threshold 3.5V, Output Type Nch Open Drain and Taping Type T1, is designated by Part Number RH5VL35AA-T1.

## PIN CONFIGURATION

• TO-92

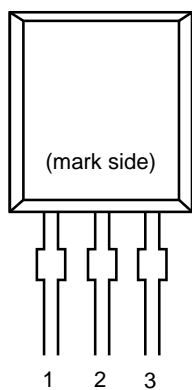

• SOT-89

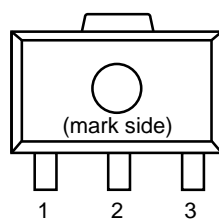

• SOT-23-5

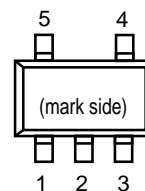

## PIN DESCRIPTION

• TO-92

Pin No	Symbol
1	OUT
2	VDD
3	GND

• SOT-89

Pin No	Symbol
1	OUT
2	VDD
3	GND

• SOT-23-5

Pin No	Symbol
1	OUT
2	VDD
3	GND
4	NC
5	NC



## ABSOLUTE MAXIMUM RATINGS

$T_{opt}=25^{\circ}\text{C}$

Symbol	Item	Rating		Unit
VDD	Supply Voltage	12		V
VOUT	Output Voltage	CMOS	$V_{SS}-0.3$ to $V_{DD}+0.3$	V
		Nch	$V_{SS}-0.3$ to 12	
IOUT	Output Current	70		mA
PD1	Power Dissipation 1 (NOTE1)	300		mW
PD2	Power Dissipation 2 (NOTE2)	150		mW
T <sub>opt</sub>	Operating Temperature Range	-30 to +80		°C
T <sub>stg</sub>	Storage Temperature Range	-55 to +125		°C
T <sub>solder</sub>	Lead Temperature (Soldering)	260°C,10s		

(NOTE 1) applied to SOT-89 and TO-92

(NOTE 2) applied to SOT-23-5

### ABSOLUTE MAXIMUM RATINGS

Absolute Maximum ratings are threshold limit values that must not be exceeded even for an instant under any conditions. Moreover, such values for any two items must not be reached simultaneously. Operation above these absolute maximum ratings may cause degradation or permanent damage to the device. These are stress ratings only and do not necessarily imply functional operation below these limits.

## ELECTRICAL CHARACTERISTICS

## • R5VL20C

T<sub>opt</sub>=25°C

Symbol	Item	Conditions	MIN.	TYP.	MAX.	Unit
-V <sub>DET</sub>	Detector Threshold		1.950	2.000	2.050	V
V <sub>HYS</sub>	Detector Threshold Hysteresis		0.060	0.100	0.140	V
I <sub>SS</sub>	Supply Current	V <sub>DD</sub> =1.90V		0.90	2.70	μA
		V <sub>DD</sub> =4.00V		1.10	3.30	
		V <sub>DD</sub> =10.0V		1.70	5.10	
V <sub>DD</sub>	Operating Voltage		1.50		10.0	V
I <sub>OUT</sub>	Output Current	Nch V <sub>DS</sub> =0.5V V <sub>DD</sub> =1.5V	0.25	0.50		mA
		Pch V <sub>DS</sub> =-2.1V V <sub>DD</sub> =4.5V	1.00	2.00		mA
t <sub>PLH</sub>	Output Delay Time				100	μs
$\frac{\Delta-V_{DET}}{\Delta T_{opt}}$	Detector Threshold Temperature Coefficient	-30°C ≤ T <sub>opt</sub> ≤ 80°C		±100		ppm/°C

## • R5VL27C

T<sub>opt</sub>=25°C

Symbol	Item	Conditions	MIN.	TYP.	MAX.	Unit
-V <sub>DET</sub>	Detector Threshold		2.633	2.700	2.767	V
V <sub>HYS</sub>	Detector Threshold Hysteresis		0.081	0.135	0.189	V
I <sub>SS</sub>	Supply Current	V <sub>DD</sub> =2.60V		0.90	2.70	μA
		V <sub>DD</sub> =4.70V		1.10	3.30	
		V <sub>DD</sub> =10.0V		1.70	5.10	
V <sub>DD</sub>	Operating Voltage		1.50		10.0	V
I <sub>OUT</sub>	Output Current	Nch V <sub>DS</sub> =0.5V V <sub>DD</sub> =1.5V	0.25	0.50		mA
		Nch V <sub>DS</sub> =0.5V V <sub>DD</sub> =2.0V	1.50	3.00		mA
		Pch V <sub>DS</sub> =-2.1V V <sub>DD</sub> =4.5V	1.00	2.00		mA
t <sub>PLH</sub>	Output Delay Time				100	μs
$\frac{\Delta-V_{DET}}{\Delta T_{opt}}$	Detector Threshold Temperature Coefficient	-30°C ≤ T <sub>opt</sub> ≤ 80°C		±100		ppm/°C

• R5VL36C

T<sub>opt</sub>=25°C

Symbol	Item	Conditions	MIN.	TYP.	MAX.	Unit
-V <sub>DET</sub>	Detector Threshold		3.510	3.600	3.690	V
V <sub>HYS</sub>	Detector Threshold Hysteresis		0.108	0.180	0.252	V
I <sub>SS</sub>	Supply Current	V <sub>DD</sub> =3.47V		1.00	3.00	μA
		V <sub>DD</sub> =5.60V		1.20	3.60	
		V <sub>DD</sub> =10.0V		1.70	5.10	
V <sub>DD</sub>	Operating Voltage		1.50		10.0	V
I <sub>OUT</sub>	Output Current	Nch V <sub>DS</sub> =0.5V V <sub>DD</sub> =1.5V	0.25	0.50		mA
		Nch V <sub>DS</sub> =0.5V V <sub>DD</sub> =3.0V	3.00	5.00		mA
		Pch V <sub>DS</sub> =-2.1V V <sub>DD</sub> =4.5V	1.00	2.00		mA
t <sub>PLH</sub>	Output Delay Time				100	μs
$\frac{\Delta -V_{DET}}{\Delta T_{opt}}$	Detector Threshold Temperature Coefficient	-30°C ≤ T <sub>opt</sub> ≤ 80°C		±100		ppm/°C

• R5VL45C

T<sub>opt</sub>=25°C

Symbol	Item	Conditions	MIN.	TYP.	MAX.	Unit
-V <sub>DET</sub>	Detector Threshold		4.388	4.500	4.612	V
V <sub>HYS</sub>	Detector Threshold Hysteresis		0.135	0.225	0.315	V
I <sub>SS</sub>	Supply Current	V <sub>DD</sub> =4.34V		1.10	3.30	μA
		V <sub>DD</sub> =6.50V		1.30	3.90	
		V <sub>DD</sub> =10.0V		1.70	5.10	
V <sub>DD</sub>	Operating Voltage		1.50		10.0	V
I <sub>OUT</sub>	Output Current	Nch V <sub>DS</sub> =0.5V V <sub>DD</sub> =1.5V	0.25	0.50		mA
		Nch V <sub>DS</sub> =0.5V V <sub>DD</sub> =4.0V	4.00	6.00		mA
		Pch V <sub>DS</sub> =-2.1V V <sub>DD</sub> =8.0V	1.50	3.00		mA
t <sub>PLH</sub>	Output Delay Time				100	μs
$\frac{\Delta -V_{DET}}{\Delta T_{opt}}$	Detector Threshold Temperature Coefficient	-30°C ≤ T <sub>opt</sub> ≤ 80°C		±100		ppm/°C

## • R5VL54C

T<sub>opt</sub>=25°C

Symbol	Item	Conditions	MIN.	TYP.	MAX.	Unit
-V <sub>DET</sub>	Detector Threshold		5.265	5.400	5.535	V
V <sub>HYS</sub>	Detector Threshold Hysteresis		0.162	0.270	0.378	V
I <sub>SS</sub>	Supply Current	V <sub>DD</sub> =5.20V		1.20	3.60	μA
		V <sub>DD</sub> =7.40V		1.40	4.20	
		V <sub>DD</sub> =10.0V		1.70	5.10	
V <sub>DD</sub>	Operating Voltage		1.50		10.0	V
I <sub>OUT</sub>	Output Current	Nch V <sub>DS</sub> =0.5V V <sub>DD</sub> =1.5V	0.25	0.50		mA
		Nch V <sub>DS</sub> =0.5V V <sub>DD</sub> =5.0V	5.00	7.00		mA
		Pch V <sub>DS</sub> =-2.1V V <sub>DD</sub> =8.0V	1.50	3.00		mA
t <sub>PLH</sub>	Output Delay Time				100	μs
$\frac{\Delta-V_{DET}}{\Delta T_{opt}}$	Detector Threshold Temperature Coefficient	-30°C ≤ T <sub>opt</sub> ≤ 80°C		±100		ppm/°C

## ELECTRICAL CHARACTERISTICS BY DETECTOR THRESHOLD

• R5VLxA

Part Number	Detector Threshold			Detector Threshold Hysteresis		Supply Current 1			Supply Current 2			Supply Current 3		
	-V <sub>DET</sub> (V)			V <sub>HYS</sub> (V)		I <sub>SS</sub> (μA)			I <sub>SS</sub> (μA)			I <sub>SS</sub> (μA)		
	MIN.	TYP.	MAX.	MIN.	MAX.	Conditions	TYP.	MAX.	Conditions	TYP.	MAX.	Conditions	TYP.	MAX.
R5VL20A	1.950	2.000	2.050	(-V <sub>DET</sub> ) ×3%	(-V <sub>DET</sub> ) ×7%	V <sub>DD</sub> = (-V <sub>DET</sub> ) -0.10V	0.9	2.7	V <sub>DD</sub> = (-V <sub>DET</sub> ) +2.0V	1.1	3.3	V <sub>DD</sub> = 10V	1.7	5.1
R5VL21A	2.048	2.100	2.152											
R5VL22A	2.145	2.200	2.255											
R5VL23A	2.243	2.300	2.357											
R5VL24A	2.340	2.400	2.460											
R5VL25A	2.438	2.500	2.562											
R5VL26A	2.535	2.600	2.665											
R5VL27A	2.633	2.700	2.767											
R5VL28A	2.730	2.800	2.870											
R5VL29A	2.828	2.900	2.972											
R5VL30A	2.925	3.000	3.075											
R5VL31A	3.023	3.100	3.177											
R5VL32A	3.120	3.200	3.280											
R5VL33A	3.218	3.300	3.382											
R5VL34A	3.315	3.400	3.485											
R5VL35A	3.413	3.500	3.587											
R5VL36A	3.510	3.600	3.690											
R5VL37A	3.608	3.700	3.792											
R5VL38A	3.705	3.800	3.895											
R5VL39A	3.803	3.900	3.997											
R5VL40A	3.900	4.000	4.100											
R5VL41A	3.998	4.100	4.202											
R5VL42A	4.095	4.200	4.305											
R5VL43A	4.193	4.300	4.407											
R5VL44A	4.290	4.400	4.510											
R5VL45A	4.388	4.500	4.612											
R5VL46A	4.485	4.600	4.715											
R5VL47A	4.583	4.700	4.817											
R5VL48A	4.680	4.800	4.920											
R5VL49A	4.778	4.900	5.022											
R5VL50A	4.875	5.000	5.125											
R5VL51A	4.973	5.100	5.227											
R5VL52A	5.070	5.200	5.330											
R5VL53A	5.168	5.300	5.432											
R5VL54A	5.265	5.400	5.535											
R5VL55A	5.363	5.500	5.637											
R5VL56A	5.460	5.600	5.740											
R5VL57A	5.558	5.700	5.842											
R5VL58A	5.655	5.800	5.945											
R5VL59A	5.753	5.900	6.047											
						V <sub>DD</sub> = (-V <sub>DET</sub> ) -0.16V								
						V <sub>DD</sub> = (-V <sub>DET</sub> ) -0.20V								

T<sub>opt</sub>=25°C

Output Current 1			Output Current 2			Output Delay Time	Operating Voltage		Detector Threshold Tempco.	
I <sub>out</sub> (mA)			I <sub>out</sub> (mA)			t <sub>PLH</sub> (μs)	V <sub>DD</sub> (V)		Δ-V <sub>DET</sub> /ΔT <sub>opt</sub> (ppm/°C)	
Conditions	MIN.	TYP.	Conditions	MIN.	TYP.	MAX.	MIN.	MAX.	Conditions	TYP.
Nch  V <sub>DS</sub> = 0.5V  V <sub>DD</sub> = 1.5V	0.25	0.50	—	—	—	100	1.5	10	-30°C ≤ T <sub>opt</sub> ≤ 80°C	±100
			Nch  V <sub>DS</sub> = 0.5V  V <sub>DD</sub> = 2.0V	1.5	3.0					
			Nch  V <sub>DS</sub> = 0.5V  V <sub>DD</sub> = 3.0V	3.0	5.0					
			Nch  V <sub>DS</sub> = 0.5V  V <sub>DD</sub> = 4.0V	4.0	6.0					
			Nch  V <sub>DS</sub> = 0.5V  V <sub>DD</sub> = 5.0V	5.0	7.0					

• R5VLxC

Part Number	Detector Threshold			Detector Threshold Hysteresis		Supply Current 1			Supply Current 2			Supply Current 3		
	-V <sub>DET</sub> (V)			V <sub>HYS</sub> (V)		I <sub>SS</sub> (μA)			I <sub>SS</sub> (μA)			I <sub>SS</sub> (μA)		
	MIN.	TYP.	MAX.	MIN.	MAX.	Conditions	TYP.	MAX.	Conditions	TYP.	MAX.	Conditions	TYP.	MAX.
R5VL20C	1.950	2.000	2.050	(-V <sub>DET</sub> ) ×3%	(-V <sub>DET</sub> ) ×7%	V <sub>DD</sub> = (-V <sub>DET</sub> ) -0.10V	0.9	2.7	V <sub>DD</sub> = (-V <sub>DET</sub> ) +2.0V	1.1	3.3	V <sub>DD</sub> = 10V	1.7	5.1
R5VL21C	2.048	2.100	2.152											
R5VL22C	2.145	2.200	2.255											
R5VL23C	2.243	2.300	2.357											
R5VL24C	2.340	2.400	2.460											
R5VL25C	2.438	2.500	2.562											
R5VL26C	2.535	2.600	2.665											
R5VL27C	2.633	2.700	2.767											
R5VL28C	2.730	2.800	2.870											
R5VL29C	2.828	2.900	2.972											
R5VL30C	2.925	3.000	3.075											
R5VL31C	3.023	3.100	3.177											
R5VL32C	3.120	3.200	3.280											
R5VL33C	3.218	3.300	3.382											
R5VL34C	3.315	3.400	3.485											
R5VL35C	3.413	3.500	3.587											
R5VL36C	3.510	3.600	3.690											
R5VL37C	3.608	3.700	3.792											
R5VL38C	3.705	3.800	3.895											
R5VL39C	3.803	3.900	3.997											
R5VL40C	3.900	4.000	4.100											
R5VL41C	3.998	4.100	4.202											
R5VL42C	4.095	4.200	4.305											
R5VL43C	4.193	4.300	4.407											
R5VL44C	4.290	4.400	4.510											
R5VL45C	4.388	4.500	4.612											
R5VL46C	4.485	4.600	4.715											
R5VL47C	4.583	4.700	4.817											
R5VL48C	4.680	4.800	4.920											
R5VL49C	4.778	4.900	5.022											
R5VL50C	4.875	5.000	5.125											
R5VL51C	4.973	5.100	5.227											
R5VL52C	5.070	5.200	5.330											
R5VL53C	5.168	5.300	5.432											
R5VL54C	5.265	5.400	5.535											
R5VL55C	5.363	5.500	5.637											
R5VL56C	5.460	5.600	5.740											
R5VL57C	5.558	5.700	5.842											
R5VL58C	5.655	5.800	5.945											
R5VL59C	5.753	5.900	6.047											

Topt=25°C

Output Current 1			Output Current 2			Output Current 3			Output Delay Time	Operating Voltage		Detector Threshold Tempco.	
Iout(mA)			Iout(mA)			Iout(mA)			tPLH (μs)	VDD(V)		Δ-VoE/ΔTopt (ppm/°C)	
Conditions	MIN.	TYP.	Conditions	MIN.	TYP.	Conditions	MIN.	TYP.	MAX.	MIN.	MAX.	Conditions	TYP.
Nch	0.25	0.50	—	—	—	Pch	1.0	2.0	100	1.5	10	-30°C ≤ Topt ≤ 80°C	±100
			Nch	VDS= 0.5V	1.5								
			VDD= 2.0V	Nch	VDS= 0.5V	3.0	5.0	VDS= -2.1V					
			VDD= 3.0V		VDS= 0.5V	4.0	6.0	VDS= -2.1V					
Nch	VDS= 0.5V	5.0	7.0	VDS= -2.1V									



## OPERATION

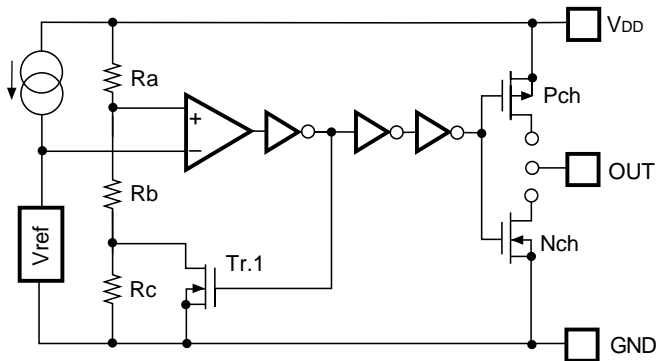

FIG. 1 Block Diagram

- In R5VLxA, Nch Tr. drain is connected to OUT pin.
- In R5VLxC, Nch Tr. drain and Pch Tr. drain are connected to OUT pin.

## Operation Diagram

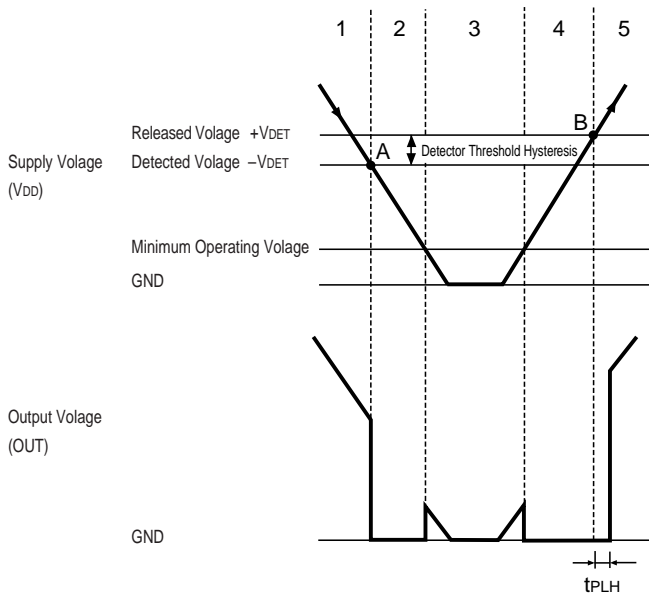

FIG. 2 Operation Diagram

Step	Step 1	Step 2	Step 3	Step 4	Step 5	
Comparator(+)Pin Input Voltage	I	II	II	II	I	
Comparator Output	H	L	Indefinite	L	H	
Tr. 1	OFF	ON	Indefinite	ON	OFF	
Output Tr.	Pch	ON	OFF	Indefinite	OFF	ON
	Nch	OFF	ON	Indefinite	ON	OFF

$$I. \frac{Rb + Rc}{Ra + Rb + Rc} \cdot V_{DD}$$

$$II. \frac{Rb}{Ra + Rb} \cdot V_{DD}$$

Step 1. Output Voltage is equal to Power Source Voltage (VDD).

Step 2. When Input Voltage to Comparator reaches the state of  $V_{ref} \geq V_{DD} \cdot (Rb + Rc) / (Ra + Rb + Rc)$  at Point A (Detected Voltage  $-V_{DET}$ ), the output of Comparator is reserved, so that Output Voltage becomes GND.

Step 3. In the case of CMOS Output, Output Voltage becomes unstable when Supply Voltage (VDD) is smaller than Minimum Operating Voltage. In the case of Nch Open Drain Output, a pulled-up voltage is output.

Step 4. Output Voltage becomes equal to GND.

Step 5. When Input Voltage to Comparator reaches the state of  $V_{ref} \leq V_{DD} \cdot (Rb) / (Ra + Rb)$  at Point B (Released Voltage  $+V_{DET}$ ), the output of Comparator is reserved, so that Output Voltage becomes equal to Supply Voltage (VDD)

## TEST CIRCUITS

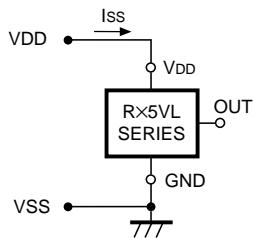

FIG. 3 Supply Current Test Circuit

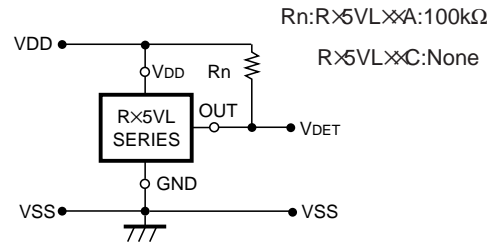

FIG. 4 Detector Threshold Test Circuit

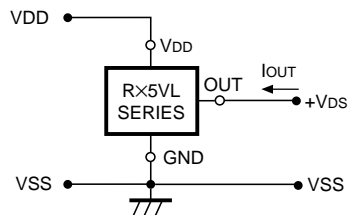

FIG. 5 Nch Driver Output Current Test Circuit

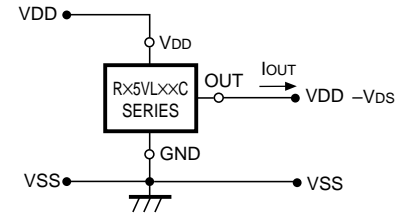

FIG. 6 Pch Driver Output Current Test Circuit

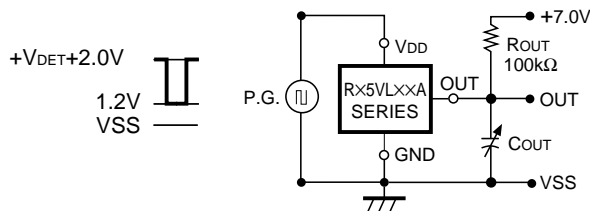
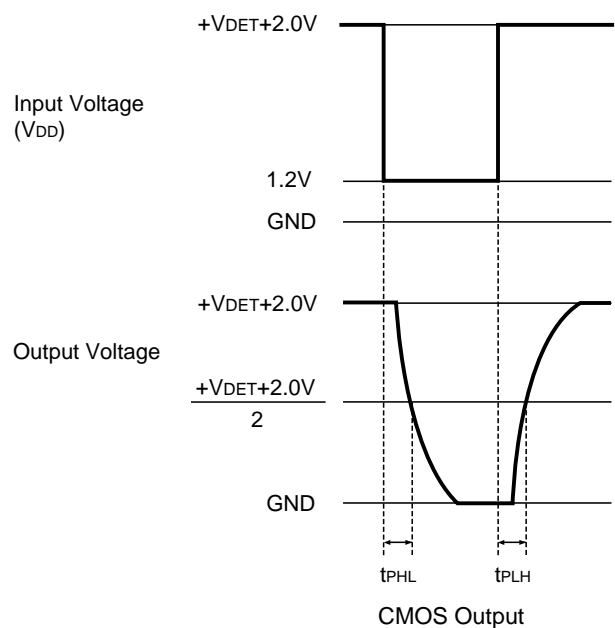
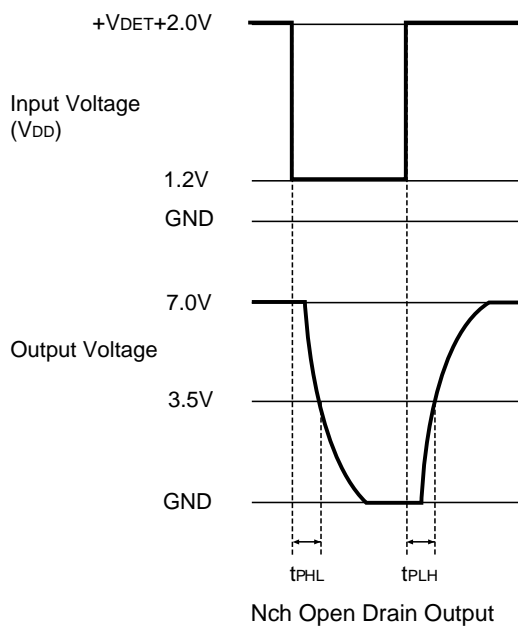

FIG. 7 Output Delay Time Test Circuit

In Output Delay Time Test Circuit in FIG.7, it's Output Voltage Fall Times ( $t_{PHL}$ ) and Rise Times ( $t_{PLH}$ ) are defined as shown below.



## TYPICAL CHARACTERISTICS

### 1) Supply Current vs. Input Voltage

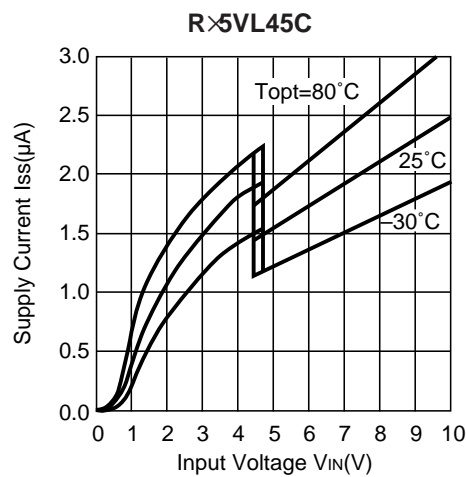
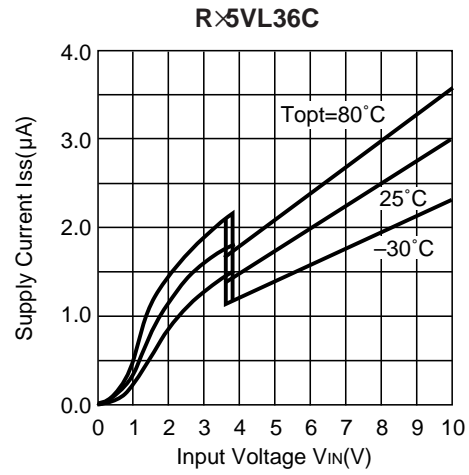
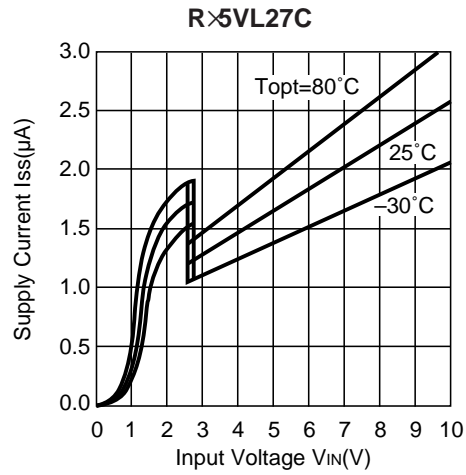

### 2) Detector Threshold vs. Temperature

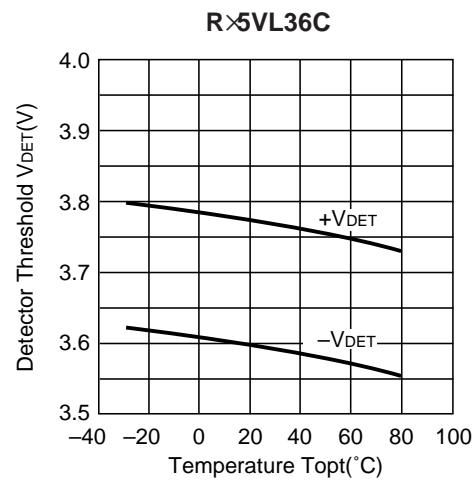
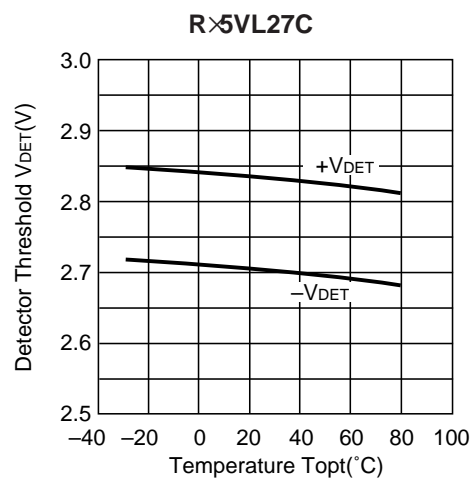

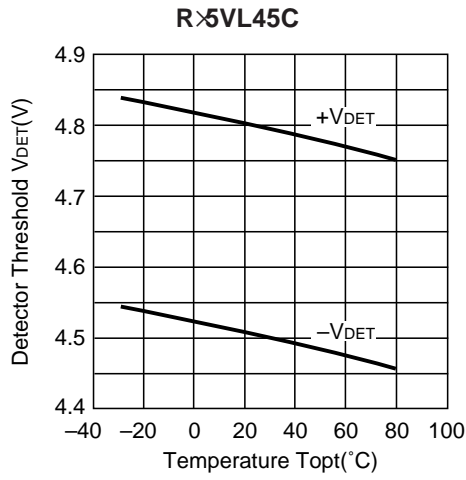

3) Output Voltage vs. Input Voltage

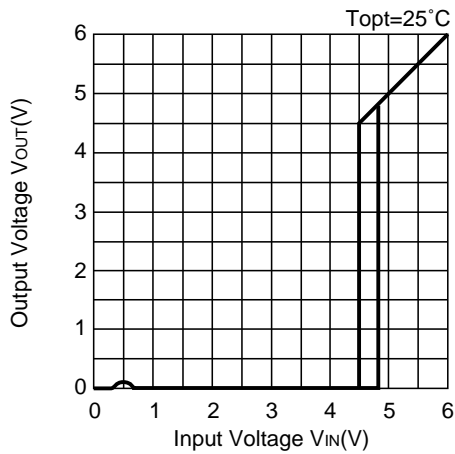
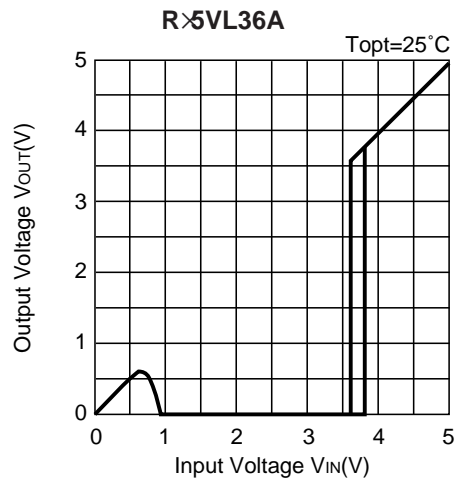
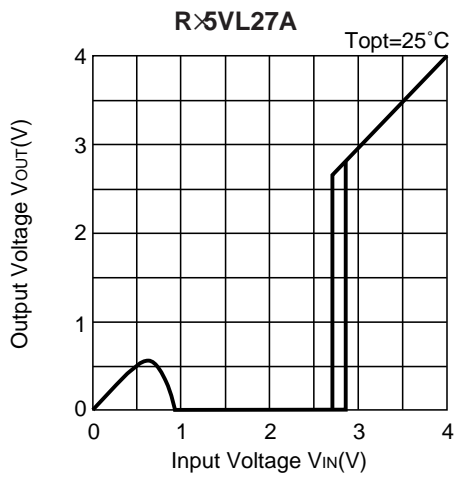

4) Nch Driver Output Current vs. V<sub>ds</sub>

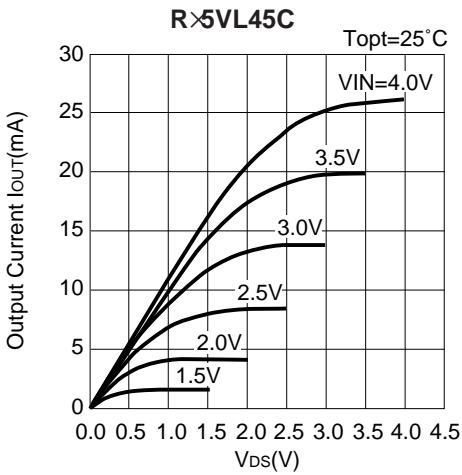
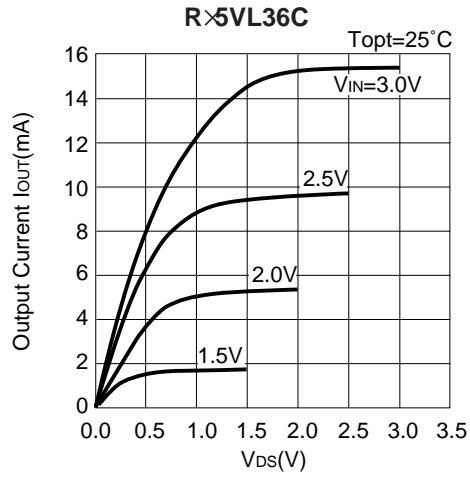
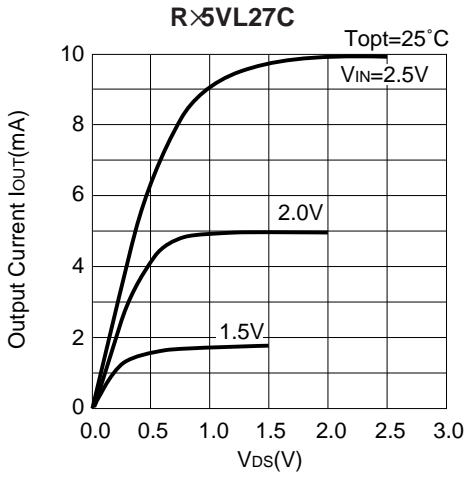

5) Nch Driver Output Current vs. Input Voltage

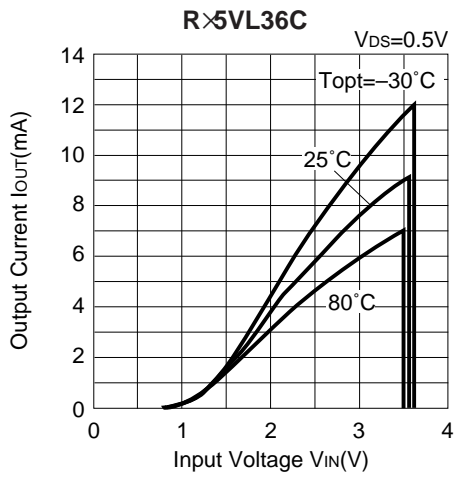
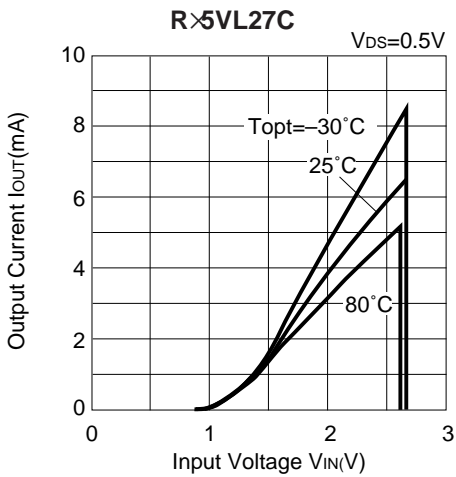

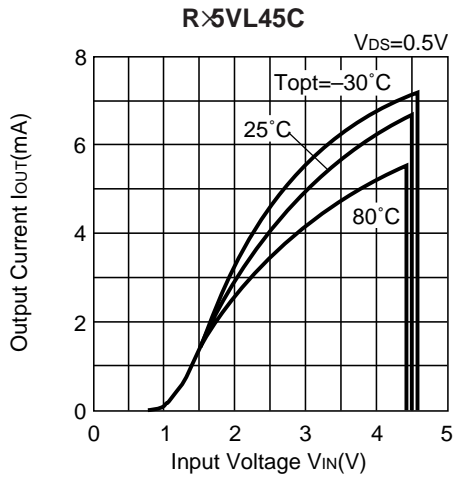

6) Pch Driver Output Current vs. Input Voltage

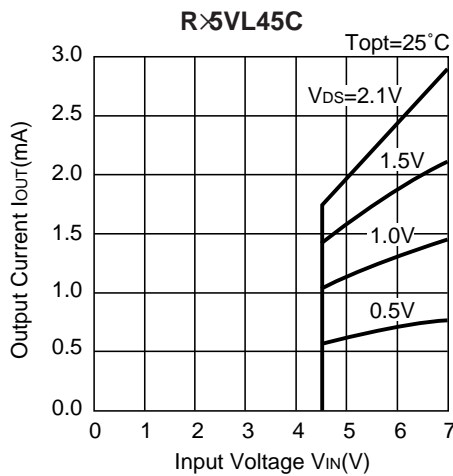
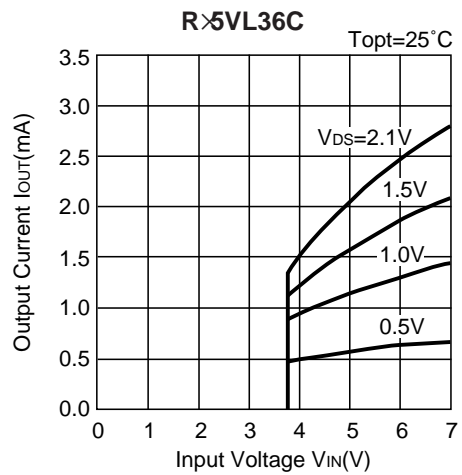
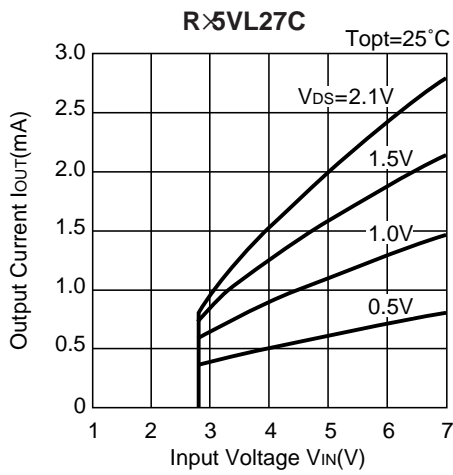

7) Output Delay Time vs. Load Capacitance

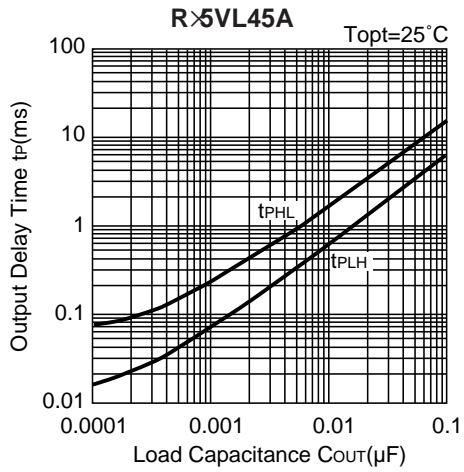
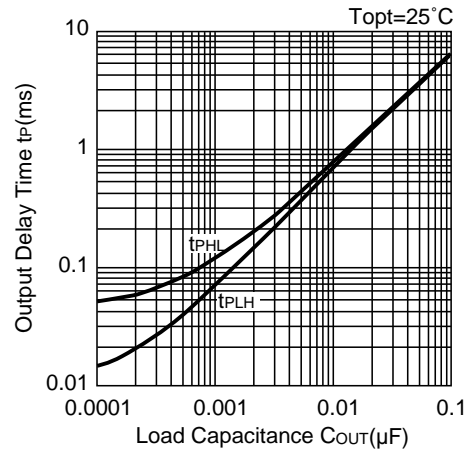
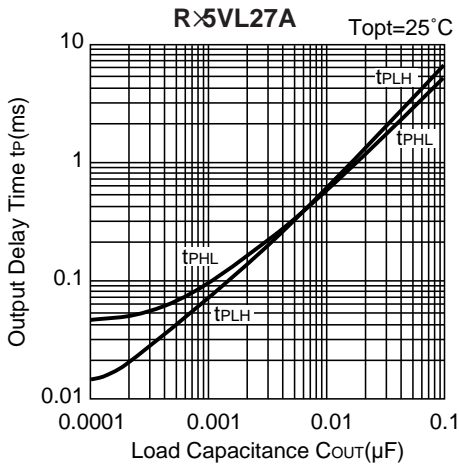

## TYPICAL APPLICATION

### • R5VLxA CPU Reset Circuit (Nch Open Drain Output)

(1) Input Voltage to R5VLxA is the same as the input voltage to CPU.

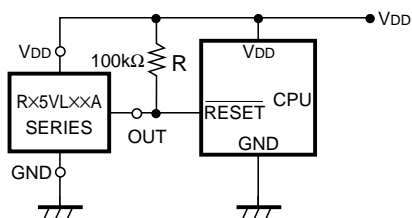

(2) Input Voltage to R5VLxA is different from the input voltage to CPU.

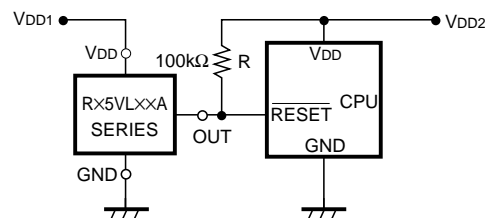

### • R5VLxC CPU Reset Circuit (CMOS Output)

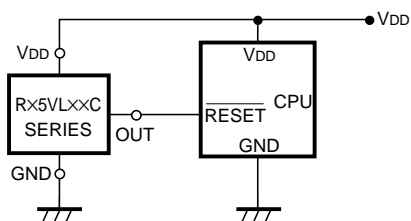

### • R5VLxA Output delay Time Circuit

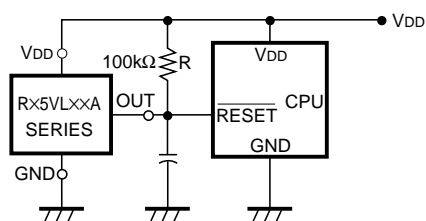

### • Memory Back-up Circuit

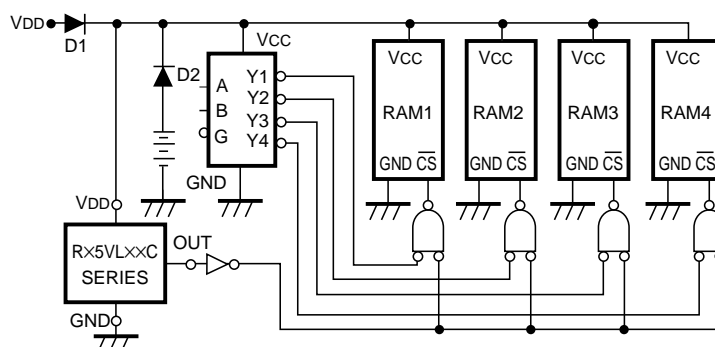



• Voltage Level Indicator Circuit (lighted when the power runs out)  
(Nch Open Drain Output)

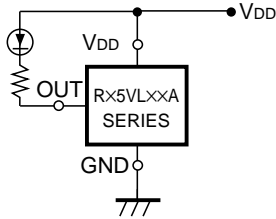

• Detector Threshold Changing Circuit  
(Nch Open Drain Output)

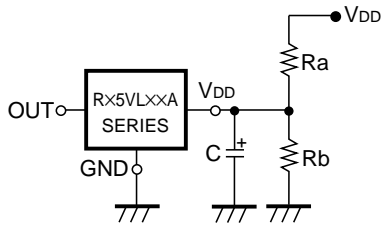

$$\text{Changed Detector Threshold} = \frac{Ra + Rb}{Rb} \cdot (-V_{DET})$$

$$\text{Hysteresis Voltage} = \frac{Ra + Rb}{Rb} \cdot V_{HYS}$$

(Note) Please note that when the value of Ra becomes excessively large, the detector threshold detected may differ from the value calculated by use of the above formula.

• Window Comparator Circuit  
(Nch Open Drain Output)

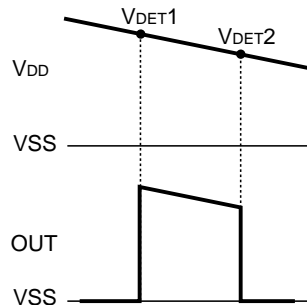
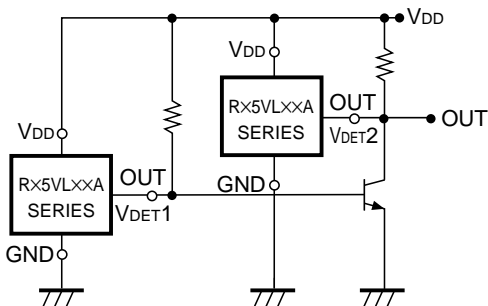

• Excessive Charge Preventing Circuit

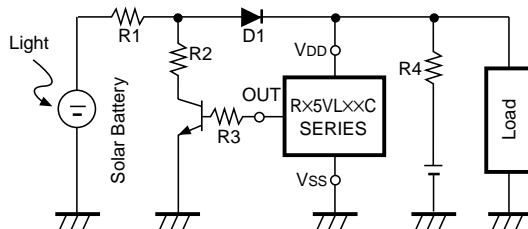

## APPLICATION HINTS

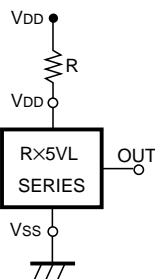

FIG. 8

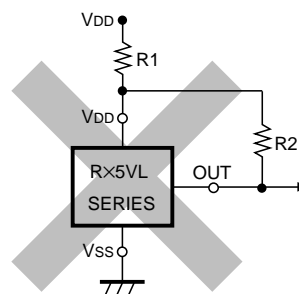
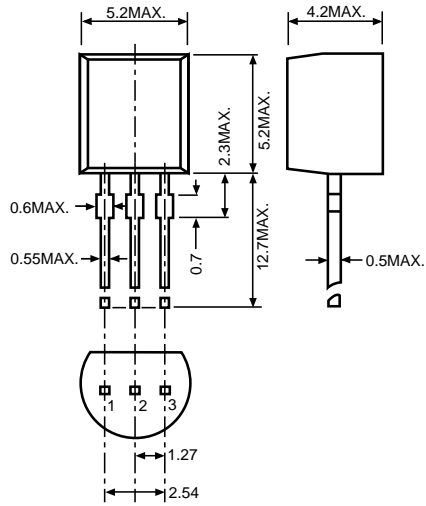

FIG. 9

1. When R5VL×C (CMOS Output) is used in FIG. 8, this IC may oscillate by the through-type current at the detection when impedance is connected between Power Source VDD and R5VL VDD Pin. When R5VL×A (Nch Open Drain Output) is used in FIG. 8, and R becomes excessively large, Detector Threshold may be varied because of the voltage drop of the supply current in the IC itself.
2. The connection as shown in FIG. 9 may cause the oscillation in both R5VL×C (CMOS Output) and R5VL×A (Nch Open Drain Output).

**PACKAGE DIMENSIONS** (Unit: mm)

• TO-92



• SOT-89

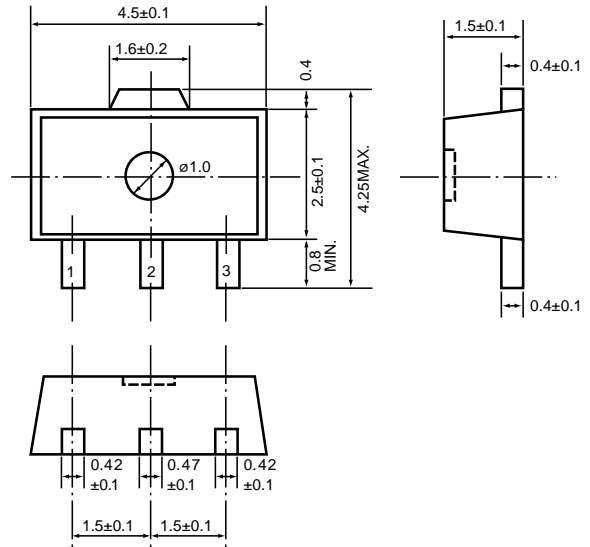

• SOT-23-5

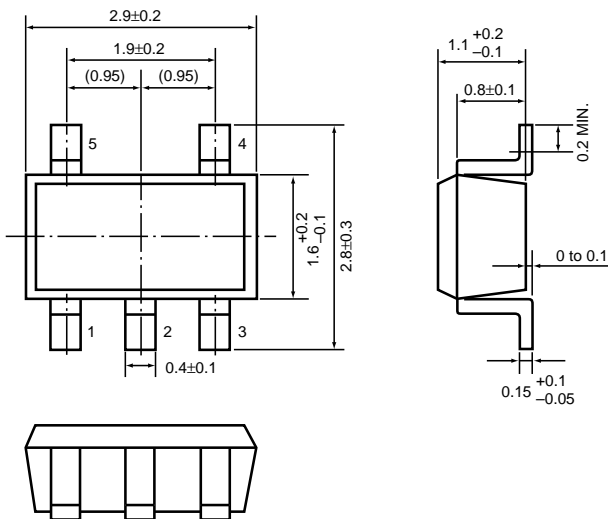

# TAPING SPECIFICATIONS (Unit: mm)

## • TO-92

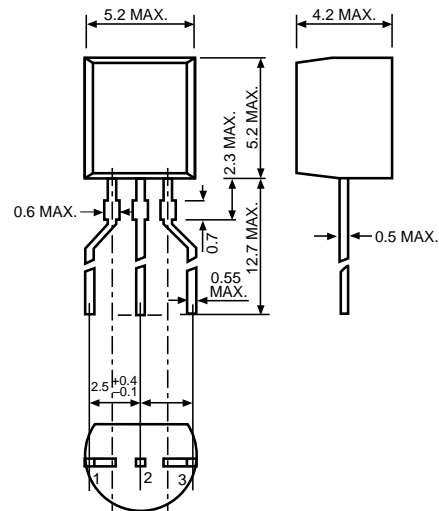
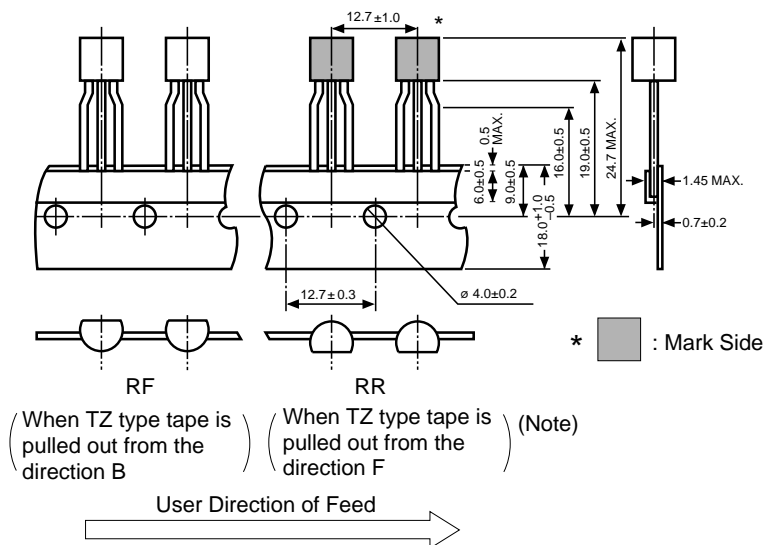

(Note) When taping is conducted, the pins of TO-92 are subjected to a particular forming.

## • SOT-89

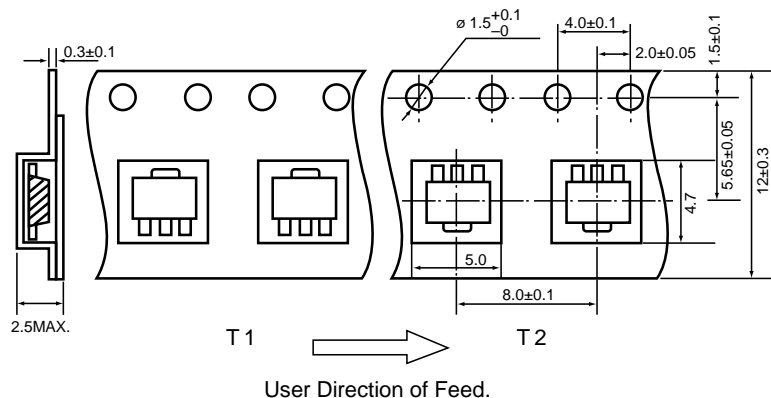

(Note) TZ type tape is not in the form of a reel, but is packed in a zigzag state in a box. Therefore, the tape can be used as either an RF type tape or an RR type tape, depending upon the pulling out direction (B or F).

## • SOT-23-5

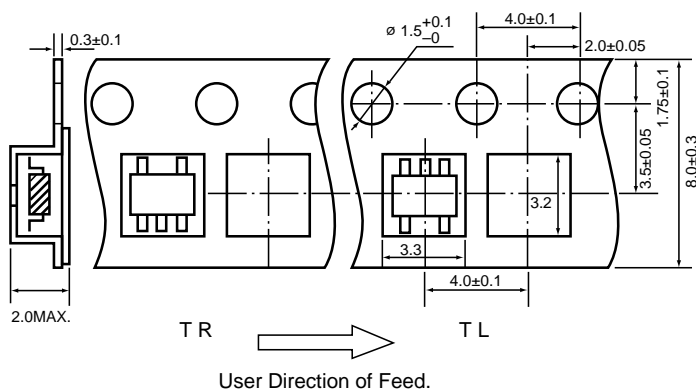



---

**RICOH COMPANY, LTD.**  
**ELECTRONIC DEVICES DIVISION**

**HEADQUARTERS**

13-1, Himemuro-cho, Ikeda City, Osaka 563-8501, JAPAN  
Phone 81-727-53-1111 Fax 81-727-53-6011

**YOKOHAMA OFFICE** (International Sales)

3-2-3, Shin-Yokohama, Kohoku-ku, Yokohama City, Kanagawa 222-8530,  
JAPAN  
Phone 81-45-477-1697 Fax 81-45-477-1694-1695  
<http://www.ricoh.co.jp/LSI/english/>

**RICOH CORPORATION**  
**ELECTRONIC DEVICES DIVISION**

**SAN JOSE OFFICE**

3001 Orchard Parkway, San Jose, CA 95134-2088, U.S.A.  
Phone 1-408-432-8800 Fax 1-408-432-8375